



JLD International BV

NL - P.O. BOX 144
1135 ZK EDAM
The Netherlands

Tel. +31 (0)299 622 396

Mail. info@JLDinternational.com
Web. www.JLDinternational.com

*Safety, quality and environment are paramount at JLD.
We are: VCA ** | ISO 9001 | CO₂ Level 5 certified.
More information can be found on our website.*



EARTH ANCHORS

The JLD-Earth Anchor is a mechanical earth anchor with comprehensive structural applications for earth anchoring in the civil, utility and maritime industries.

THE JLD-EARTH ANCHOR

Compared with other systems, the JLD-Earth Anchor offers the advantage of achieving the anchor force “without soil disturbance” due to the mechanism of installing and tilting.

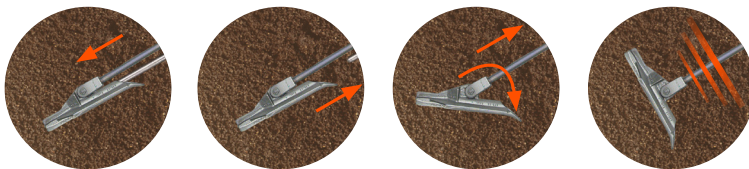

PRODUCT DATA

Type	JLD 1.0	[-]
Width	31	[mm]
Length	121	[mm]
Height	48	[mm]
Surface	3.097	[mm ²]
Fraction strength	20	[kN]
Yield strength	16	[kN]
Finish	Surface Treated	

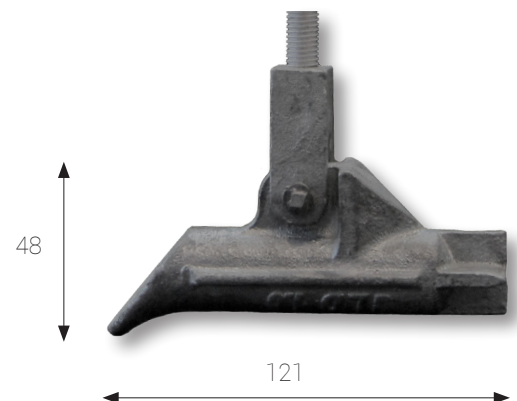

APPLICABLE ANCHOR RODS

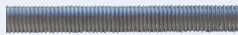
Type	Material
M10	Galvanized steel 



JLD International BV

NL - P.O. BOX 144
1135 ZK EDAM
The Netherlands

Tel. +31 (0)299 622 396

Mail. info@JLDinternational.com
Web. www.JLDinternational.com

*Safety, quality and environment are paramount at JLD.
We are: VCA ** | ISO 9001 | CO₂ Level 5 certified.
More information can be found on our website.*



EARTH ANCHORS

The JLD-Earth Anchor is a mechanical earth anchor with comprehensive structural applications for earth anchoring in the civil, utility and maritime industries.

THE JLD-EARTH ANCHOR

Compared with other systems, the JLD-Earth Anchor offers the advantage of achieving the anchor force “without soil disturbance” due to the mechanism of installing and tilting.

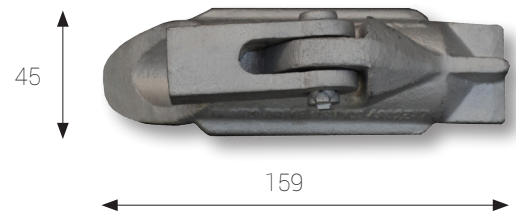
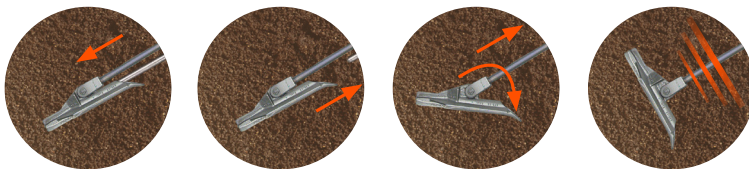

PRODUCT DATA

Type	JLD 1.2	[-]
Width	45	[mm]
Length	159	[mm]
Height	71	[mm]
Surface	6.500	[mm ²]
Fraction strength	45	[kN]
Yield strength	31	[kN]
Finish	Surface Treated	

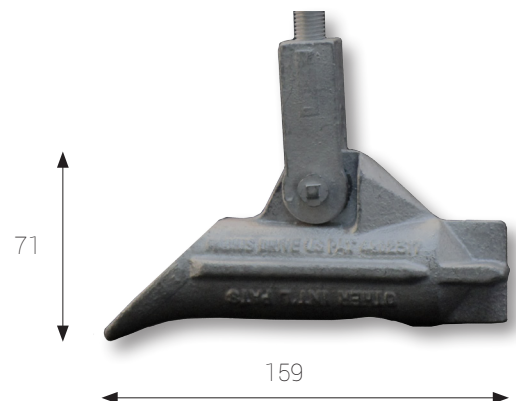

APPLICABLE ANCHOR RODS

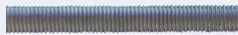
Type	Material
M12	Galvanized steel 



JLD International BV

NL - P.O. BOX 144
1135 ZK EDAM
The Netherlands

Tel. +31 (0)299 622 396

Mail. info@JLDinternational.com
Web. www.JLDinternational.com

*Safety, quality and environment are paramount at JLD.
We are: VCA ** | ISO 9001 | CO₂ Level 5 certified.
More information can be found on our website.*



EARTH ANCHORS

The JLD-Earth Anchor is a mechanical earth anchor with comprehensive structural applications for earth anchoring in the civil, utility and maritime industries.

THE JLD-EARTH ANCHOR

Compared with other systems, the JLD-Earth Anchor offers the advantage of achieving the anchor force “without soil disturbance” due to the mechanism of installing and tilting.

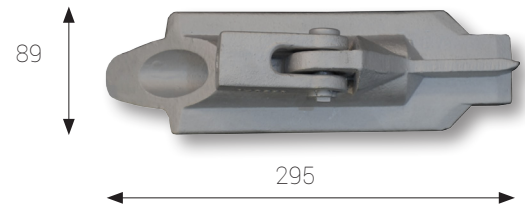
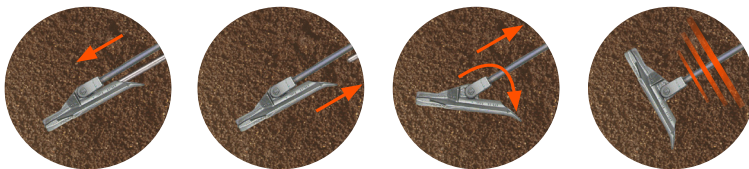

PRODUCT DATA

Type	JLD 1.4	[-]
Width	89	[mm]
Length	295	[mm]
Height	102	[mm]
Surface	21.932	[mm ²]
Fraction strength	120	[kN]
Yield strength	92,3	[kN]
Finish	Surface Treated	

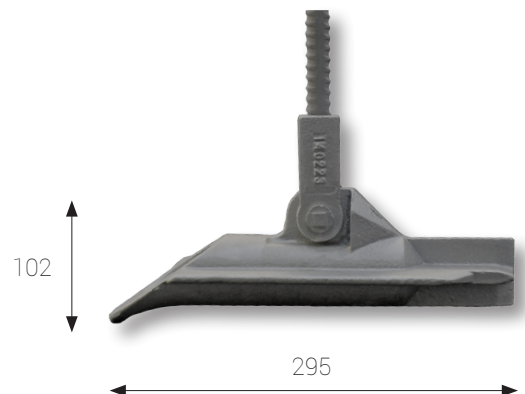

APPLICABLE ANCHOR RODS

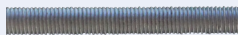
Type	Material	
GEWI® 16T	High yield screwable steel (untreated)	
M16	Galvanized steel	



JLD International BV

NL - P.O. BOX 144
1135 ZK EDAM
The Netherlands

Tel. +31 (0)299 622 396

Mail. info@JLDinternational.com
Web. www.JLDinternational.com

*Safety, quality and environment are paramount at JLD.
We are: VCA ** | ISO 9001 | CO₂ Level 5 certified.
More information can be found on our website.*



EARTH ANCHORS

The JLD-Earth Anchor is a mechanical earth anchor with comprehensive structural applications for earth anchoring in the civil, utility and maritime industries.

THE JLD-EARTH ANCHOR

Compared with other systems, the JLD-Earth Anchor offers the advantage of achieving the anchor force “without soil disturbance” due to the mechanism of installing and tilting.

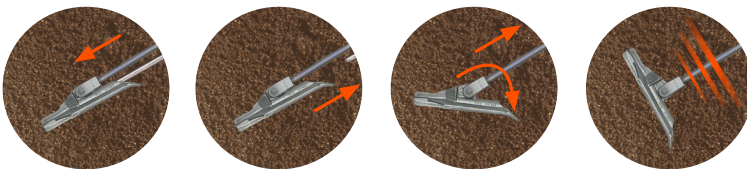

PRODUCT DATA

Type	JLD 2.2	[-]
Width	178	[mm]
Length	368	[mm]
Height	112	[mm]
Surface	48.580	[mm ²]
Fraction strength	220	[kN]
Yield strength	165	[kN]
Finish	Surface Treated	

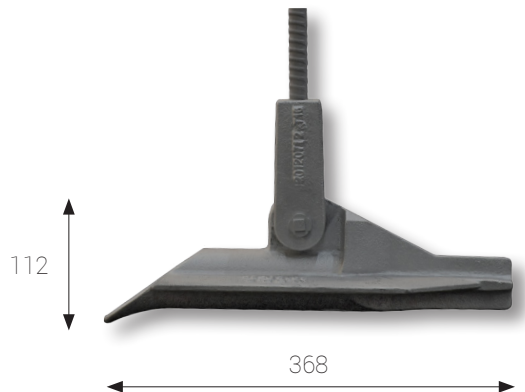

APPLICABLE ANCHOR RODS

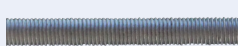
Type	Material	
GEWI® 16T, 20T, 25T	High yield screwable steel (untreated)	
M16, M20, M24	Galvanized steel	



JLD International BV

NL - P.O. BOX 144
1135 ZK EDAM
The Netherlands

Tel. +31 (0)299 622 396

Mail. info@JLDinternational.com
Web. www.JLDinternational.com

*Safety, quality and environment are paramount at JLD.
We are: VCA ** | ISO 9001 | CO₂ Level 5 certified.
More information can be found on our website.*



EARTH ANCHORS

The JLD-Earth Anchor is a mechanical earth anchor with comprehensive structural applications for earth anchoring in the civil, utility and maritime industries.

THE JLD-EARTH ANCHOR

Compared with other systems, the JLD-Earth Anchor offers the advantage of achieving the anchor force “without soil disturbance” due to the mechanism of installing and tilting.

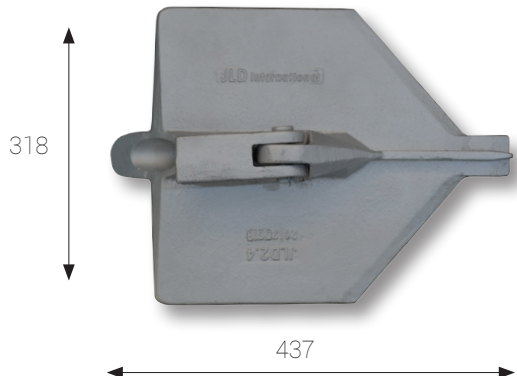
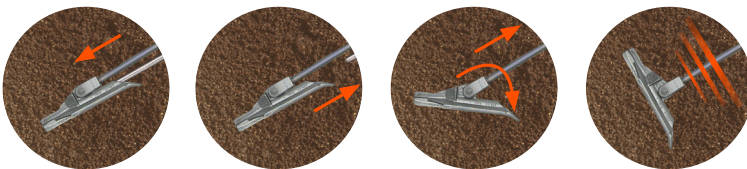

PRODUCT DATA

Type	JLD 2.4	[-]
Width	318	[mm]
Length	437	[mm]
Height	112	[mm]
Surface	93.820	[mm ²]
Fraction strength	220	[kN]
Yield strength	165	[kN]
Finish	Surface Treated	

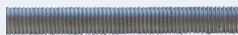

APPLICABLE ANCHOR RODS

Type	Material	
GEWI® 16T, 20T, 25T	High yield screwable steel (untreated)	
M16, M20, M24	Galvanized steel	



JLD International BV

NL - P.O. BOX 144
1135 ZK EDAM
The Netherlands

Tel. +31 (0)299 622 396

Mail. info@JLDinternational.com
Web. www.JLDinternational.com

*Safety, quality and environment are paramount at JLD.
We are: VCA ** | ISO 9001 | CO₂ Level 5 certified.
More information can be found on our website.*



EARTH ANCHORS

The JLD-Earth Anchor is a mechanical earth anchor with comprehensive structural applications for earth anchoring in the civil, utility and maritime industries.

THE JLD-EARTH ANCHOR

Compared with other systems, the JLD-Earth Anchor offers the advantage of achieving the anchor force “without soil disturbance” due to the mechanism of installing and tilting.

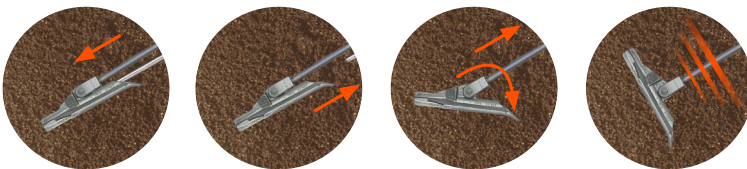

PRODUCT DATA

Type	JLD 2.8	[-]
Width	470	[mm]
Length	676	[mm]
Height	132	[mm]
Surface	231.878	[mm ²]
Fraction strength	220	[kN]
Yield strength	165	[kN]
Finish	Surface Treated	

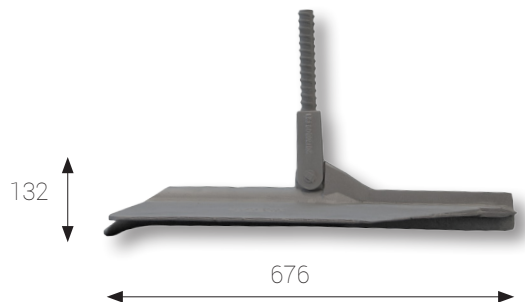

APPLICABLE ANCHOR RODS

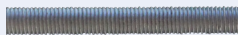
Type	Material	
GEWI® 16T, 20T, 25T	High yield screwable steel	
M16, M20, M24	Galvanized steel	



JLD International BV

NL - P.O. BOX 144
1135 ZK EDAM
The Netherlands

Tel. +31 (0)299 622 396

Mail. info@JLDinternational.com
Web. www.JLDinternational.com

*Safety, quality and environment are paramount at JLD.
We are: VCA ** | ISO 9001 | CO₂ Level 5 certified.
More information can be found on our website.*



EARTH ANCHORS

The JLD-Earth Anchor is a mechanical earth anchor with comprehensive structural applications for earth anchoring in the civil, utility and maritime industries.

THE JLD-EARTH ANCHOR

Compared with other systems, the JLD-Earth Anchor offers the advantage of achieving the anchor force “without soil disturbance” due to the mechanism of installing and tilting.

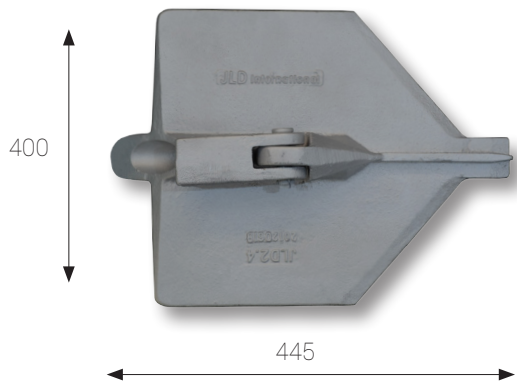
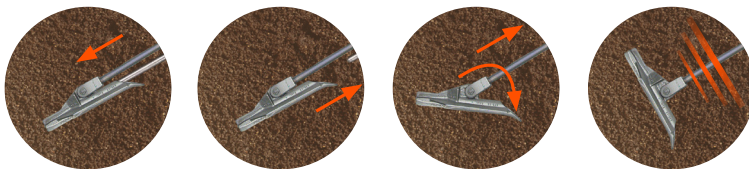

PRODUCT DATA

Type	JLD 2.6	[-]
Width	400	[mm]
Length	445	[mm]
Height	138	[mm]
Surface	156,780	[mm ²]
Fraction strength	220	[kN]
Yield strength	165	[kN]
Finish	Surface Treated	

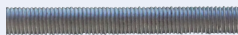

APPLICABLE ANCHOR RODS

Type	Material	
GEWI® 16T, 20T, 25T	High yield screwable steel (untreated)	
M16, M20, M24	Galvanized steel	



JLD International BV

NL - P.O. BOX 144
1135 ZK EDAM
The Netherlands

Tel. +31 (0)299 622 396

Mail. info@JLDinternational.com
Web. www.JLDinternational.com

*Safety, quality and environment are paramount at JLD.
We are: VCA ** | ISO 9001 | CO₂ Level 5 certified.
More information can be found on our website.*



EARTH ANCHORS

The JLD-Earth Anchor is a mechanical earth anchor with comprehensive structural applications for earth anchoring in the civil, utility and maritime industries.

THE JLD-EARTH ANCHOR

Compared with other systems, the JLD-Earth Anchor offers the advantage of achieving the anchor force “without soil disturbance” due to the mechanism of installing and tilting.

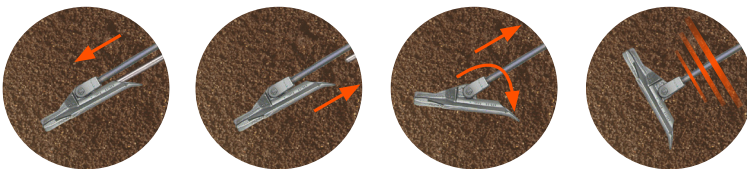

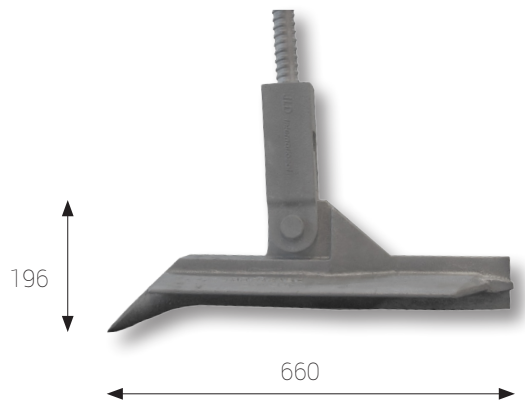

PRODUCT DATA

Type	JLD 4.2	[-]
Width	356	[mm]
Length	660	[mm]
Height	196	[mm]
Surface	189.930	[mm ²]
Fraction strength	450	[kN]
Yield strength	338	[kN]
Finish	Surface Treated	



APPLICABLE ANCHOR RODS

Type	Material	
GEWI® 25T	High yield screwable steel (untreated)	
GEWI® 25TR, 28TR, 30TR, 35TR	High yield screwable steel (untreated)	



JLD International BV

NL - P.O. BOX 144
1135 ZK EDAM
The Netherlands

Tel. +31 (0)299 622 396

Mail. info@JLDinternational.com
Web. www.JLDinternational.com

*Safety, quality and environment are paramount at JLD.
We are: VCA ** | ISO 9001 | CO₂ Level 5 certified.
More information can be found on our website.*



EARTH ANCHORS

The JLD-Earth Anchor is a mechanical earth anchor with comprehensive structural applications for earth anchoring in the civil, utility and maritime industries.

THE JLD-EARTH ANCHOR

Compared with other systems, the JLD-Earth Anchor offers the advantage of achieving the anchor force “without soil disturbance” due to the mechanism of installing and tilting.

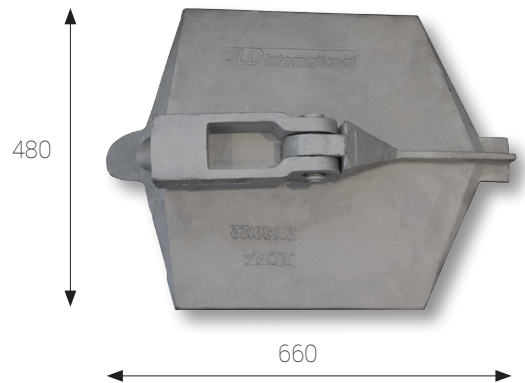
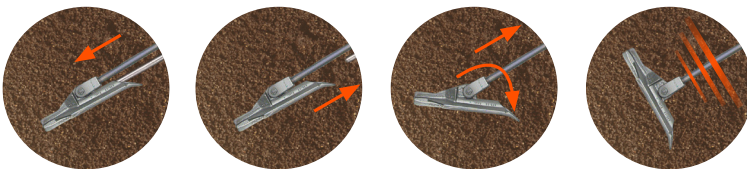

PRODUCT DATA

Type	JLD 4.4	[-]
Width	480	[mm]
Length	660	[mm]
Height	220	[mm]
Surface	238.312	[mm ²]
Fraction strength	450	[kN]
Yield strength	338	[kN]
Finish	Surface Treated	

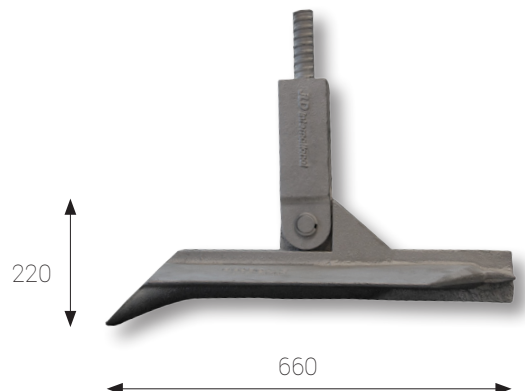

APPLICABLE ANCHOR RODS

Material	
High yield screwable steel (untreated)	
High yield screwable steel (untreated)	